

The World's Largest LNG Trains

Yamal LNG

Freeport LNG



Chiyoda's Technological Expertise and Experience in Gas Value Chain



Sakhalin Energy Investment Company

Chiyoda, Responding to New Challenges as a Pioneer in Energy Transition

Since our establishment in 1948, we have consistently endeavoured to contribute to global society based on our corporate philosophy “Energy and Environment in Harmony” whilst maximizing returns on investments for our clients. As a world leading engineering company, we have an impressive track record with projects being undertaken in more than 40 countries. The majority of our work has been focused on the energy sector and in particular to the construction of petroleum and natural gas plants.

“Chiyoda's strength and expertise lie in its ability to provide tailor-made responses to client needs.”

With safety being our core value, Chiyoda targets zero accidents and injuries. We pride ourselves on our excellent safety record and offer outstanding services which encompass master planning, engineering, procurement, construction, commissioning and maintenance.

We believe our great strength lies in the development of natural gas and, in particular, liquefied natural gas (LNG) processing facilities.

Since completing our first LNG plant in the UAE in 1976, we have consistently satisfied client requirements with our state-of-the-art technical ability and unrivaled expertise in the construction of LNG plants. See Page 16

We have successfully completed a number of highly complex projects in recent years, and actively executing ongoing LNG projects in Qatar, USA and Indonesia. See Page 9, 10 and 13

Courtesy of Qatargas Operating Company Limited



The World's Largest LNG Trains in Qatar

Courtesy of ExxonMobil PNG Limited



PNG LNG Project, Papua New Guinea

Courtesy of JSC Yamal LNG



Yamal LNG Project, Russia

Courtesy of Cameron LNG, LLC



Cameron LNG Project, USA

Courtesy of Freeport LNG Development, LP*



Freeport LNG Project, USA

“We are responding to the changing environment-friendly trends by proposing optimal solutions.”

Natural Gas has become an increasingly important energy source over recent years considering the global trends of decarbonization. We are responding to these trends by proposing optimal solutions such as the construction of LNG plants which yield superior cost performance and offer a fast delivery with modular construction, while continuing to construct conventional LNG plants. We are also ready to provide our services to meet emerging needs of decarbonization by providing CO₂ Capture and Storage (CCS) and other carbon management technology.

Chiyoda's strength and expertise lies in its ability to provide the best responses to client needs, and our total willingness, as an innovator, to undertake new challenges in the LNG segment.

We will continue to build on these strengths as we pursue our goal of creating a sustainable future for us all.

Chiyoda's LNG Experience (Chronological)

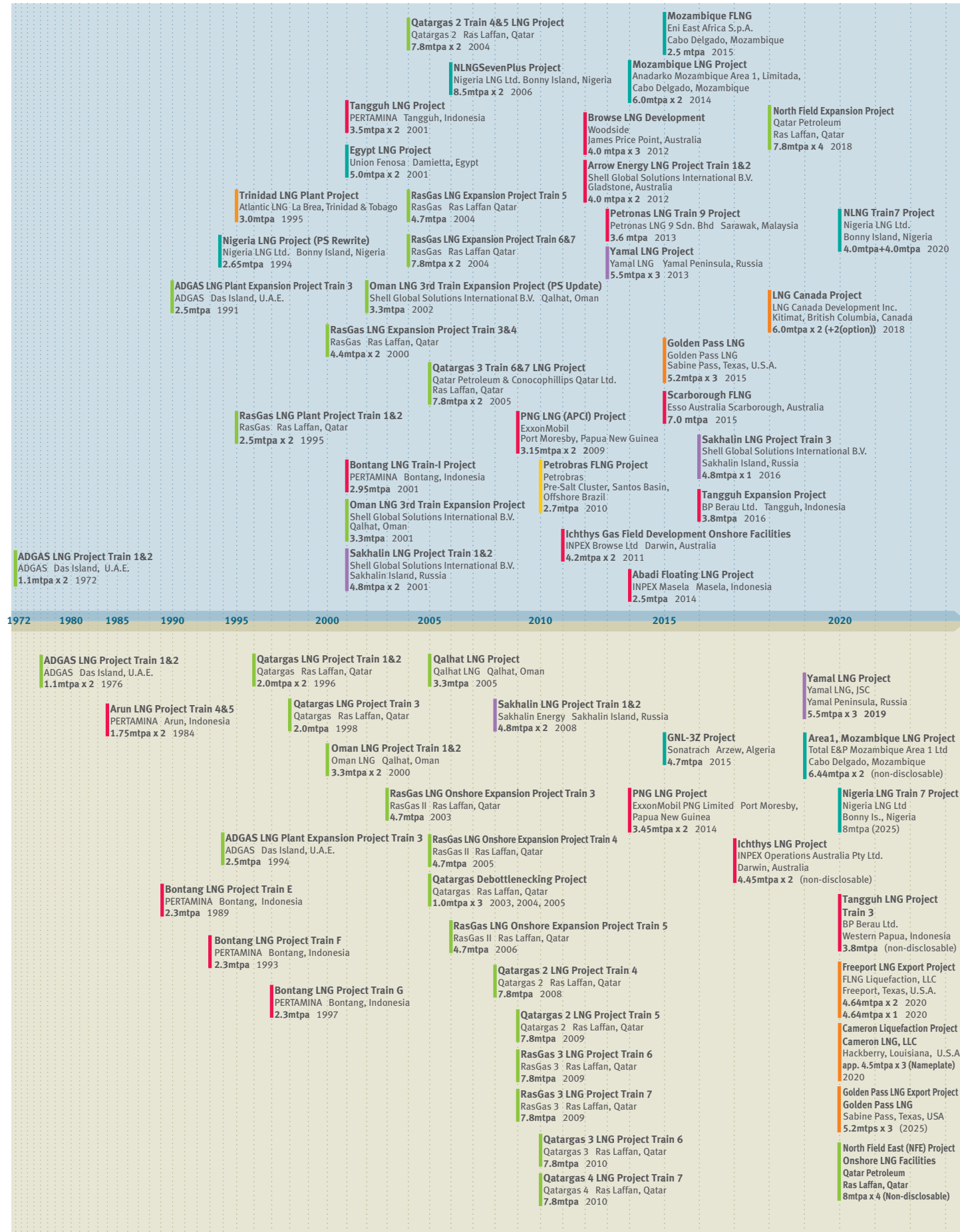

Chiyoda's LNG Experience (Geographical)

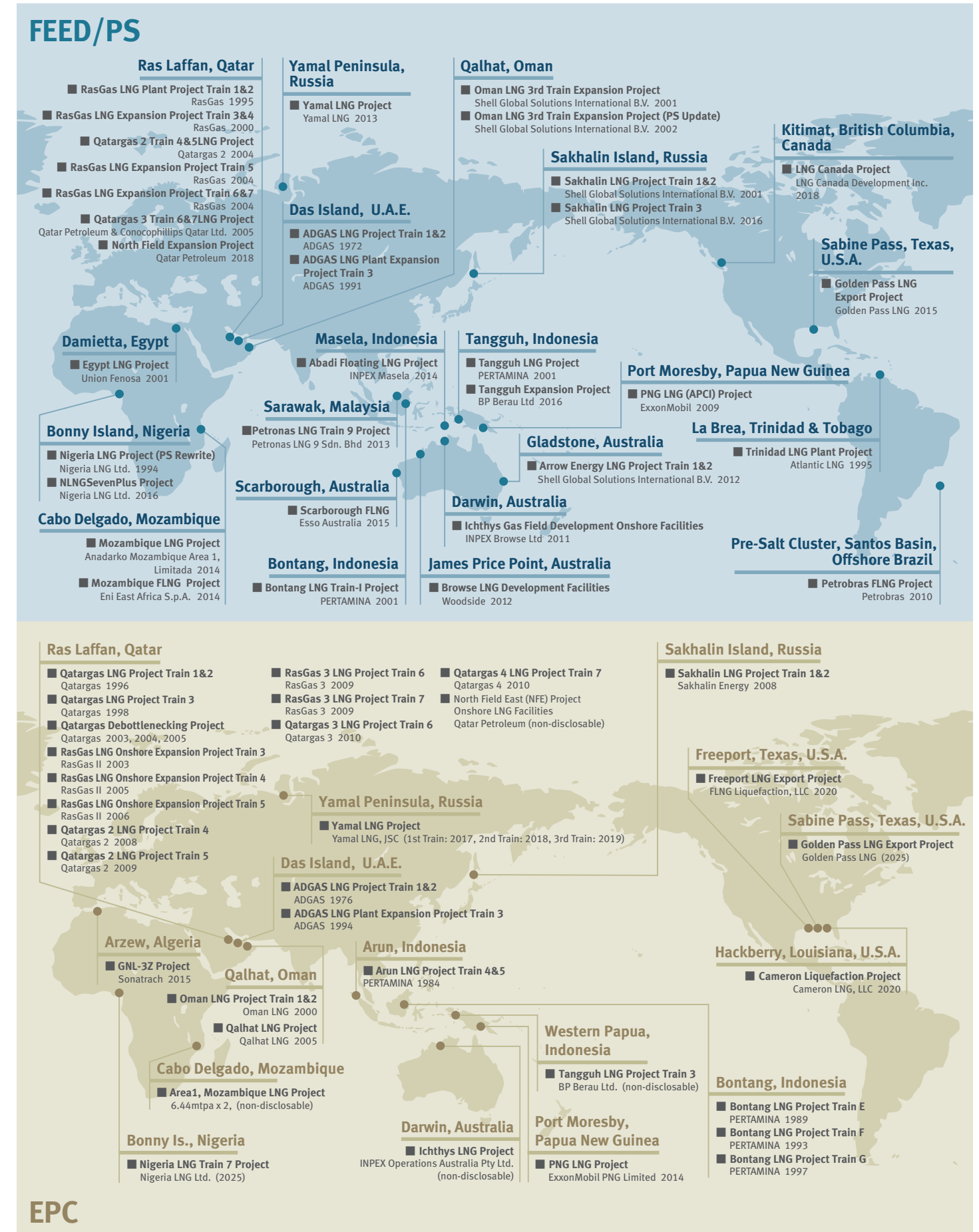

Chiyoda's Experience in Various LNG Projects and Safety Records

Experience in Various LNG Projects

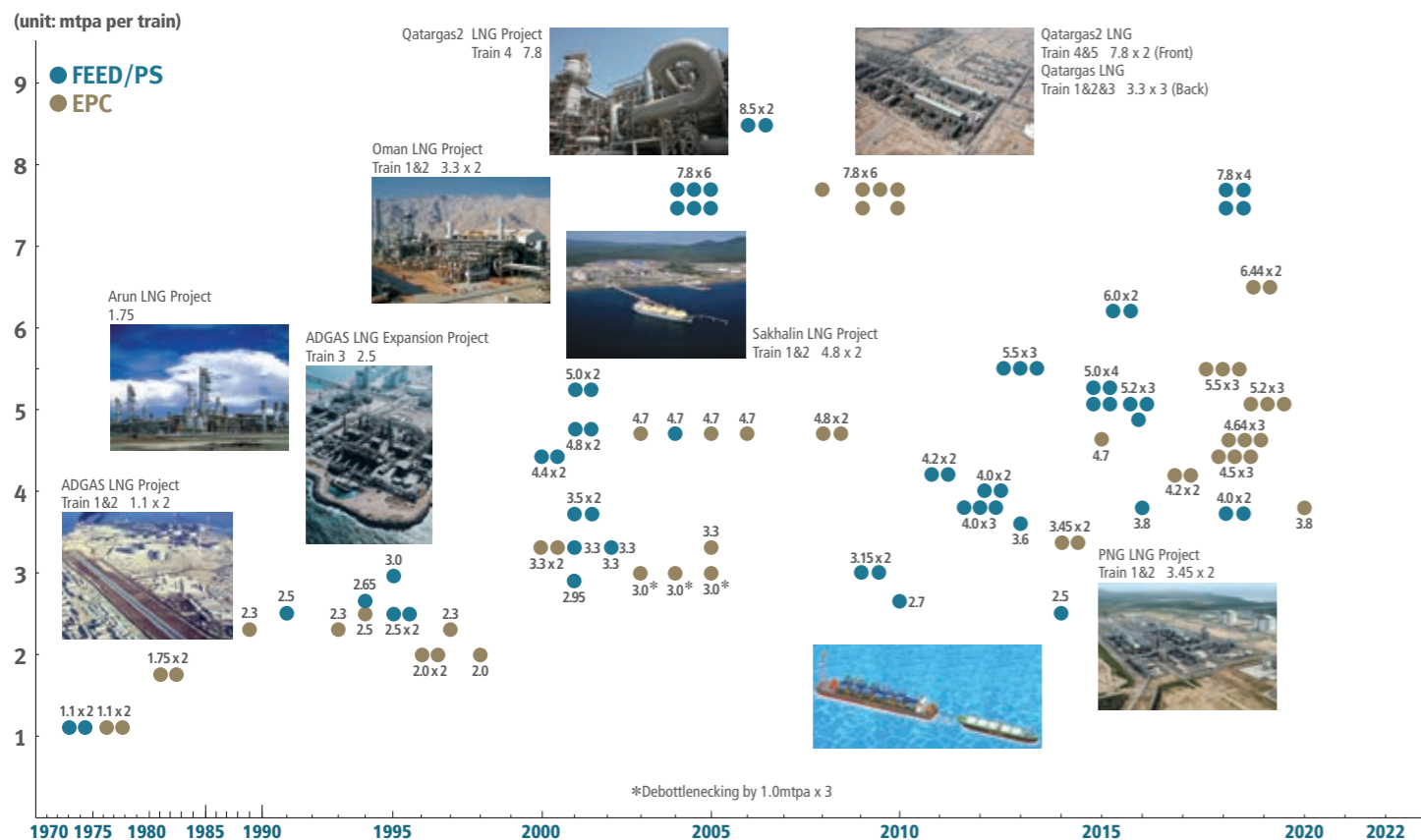

Project Summary

Safety Records in Plant Construction and in Module Fabrication Yard

As of March 2023

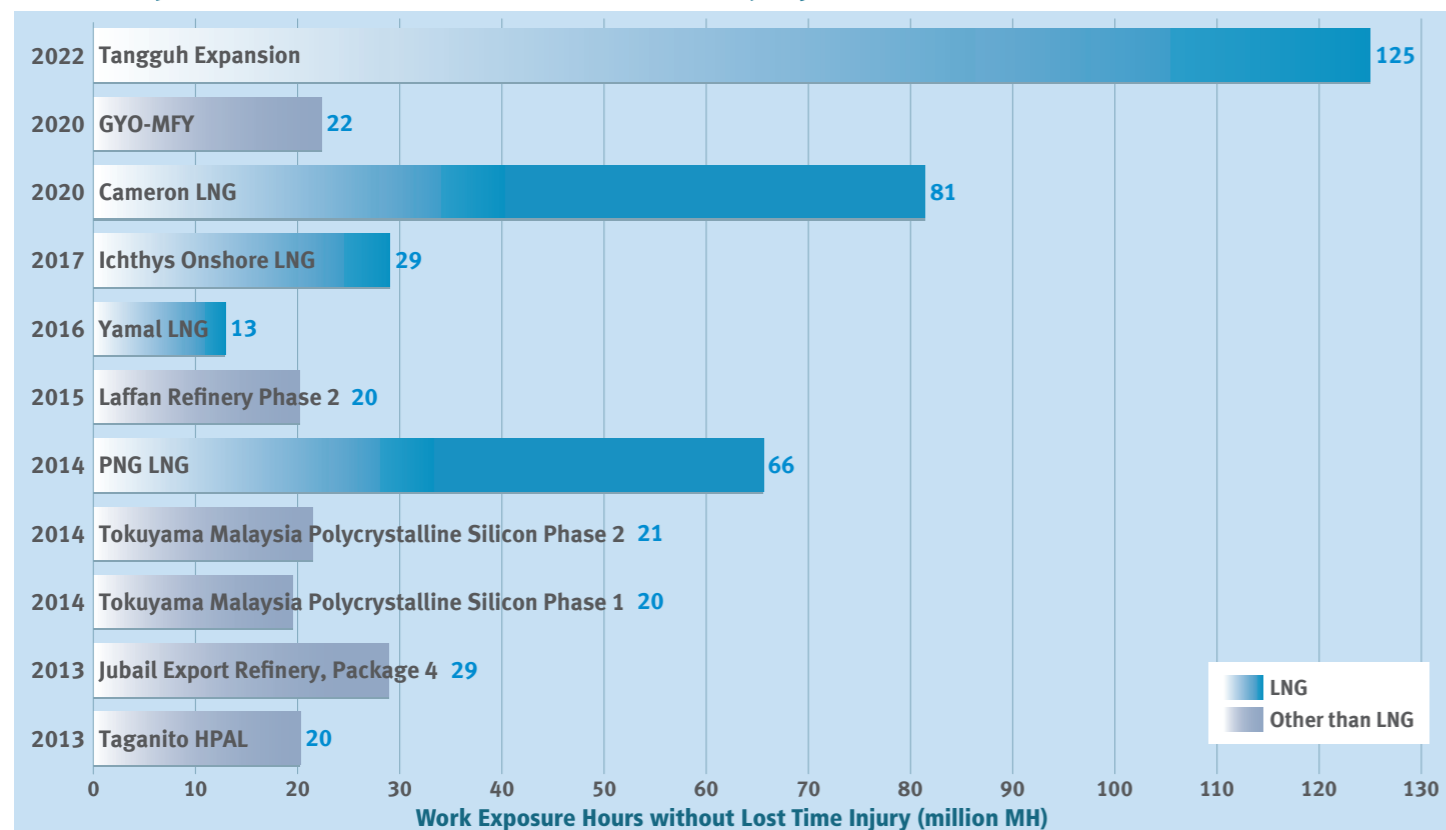

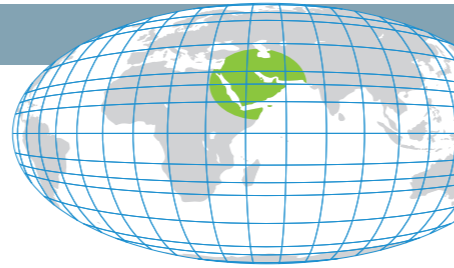

Qatargas

Client :
Qatar Liquefied Gas Company Limited

Year of Completion :
1st, 2nd & 3rd LNG Train Debottlenecking 2003, 2004, 2005
3rd LNG Train 1998
2nd LNG Train 1996
1st LNG Train 1996

Annual Production Capacity :
6 MTPA of LNG
9 MTPA tons of LNG
(after debottlenecking)

Natural-Gas Liquefaction :
APCI C₃-MR process

Chiyoda completed the first “grassroot” LNG plant in the State of Qatar, the Qatargas LNG Plant at Ras Laffan in 1996, ushering the country into a new era as an LNG exporter. During the EPC bidding stage in 1992/1993, Chiyoda carried out an independent FEED work for an Acid-Gas-Removal unit using the Shell Sulfinol process and for a Sulfur-Recovery unit using the Comprimo Superclaus process, for both of which Chiyoda is an authorized licensor. The results were accepted by Qatargas as a better solution in terms of cost effectiveness and usability than the specified processes.



The EPC contract for two LNG trains with 2 mtpa of capacity each was awarded to Chiyoda in May 1993, with an option for the third 2 mtpa train. Ready For Start-Up (RFSU) of the first train was achieved in September 1996, and that of the second train in February 1997, both a month ahead of schedule with remarkable safety records. The third train was completed in March 1998, 8 months ahead of schedule.

Debottlenecking project for trains 1/2/3 was awarded to Chiyoda/Technip JV in 2001 to increase the total production capacity from 6 mtpa to 9 mtpa.

Chiyoda Technip JV (CTJV) has completed the Debottlenecking project on time, and achieved 5.3 million man-hours No Loss Time Incident (NLTi) under the limited yearly shut-down period and in confined spaces. CTJV was awarded with “Certificate of Recognition” by Qatargas when 4 million man-hours NLTi was achieved.



Chiyoda was elected as the winner of the prestigious International Project of the Year 1999 for the Qatargas LNG Project for the Project Management Institute, the world’s leading management professional association.



Courtesy of Qatargas

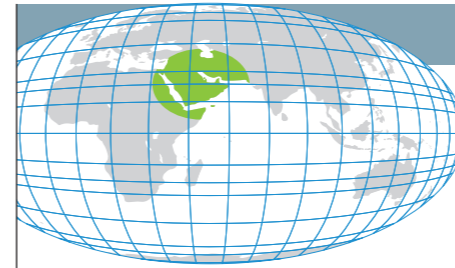

Qatargas 2

After completion of FEED work, Chiyoda with its JV partner Technip was awarded the Engineering, Procurement and Construction (EPC) contract for two LNG trains with the world’s largest capacity by Qatargas 2 in December 2004. The two trains, each with 7.8 mtpa LNG production capacity, were completed from 2008 to 2009 and began delivering LNG cargos to the market.



The award of the Qatargas 2 Train 4 & 5 established significant new benchmarks for LNG train capacity, project schedule and cost effective monetization of Qatar’s estimated massive 900 TCF gas resources. Chiyoda has been at the forefront of this relentless drive for innovative plant design and world class project execution, having been involved in every part of the gas value chain from the inception of the LNG industry.

Client :
Qatar Liquefied Gas Company Limited (2)

Year of Completion :
4th LNG Train EPC 2008
5th LNG Train EPC 2009
4th & 5th LNG Trains FEED 2004

Annual Production Capacity :
7.8 mtpa of LNG x 2 Trains

Natural-Gas Liquefaction :
APCI AP – X process

Courtesy of Qatargas



Courtesy of Qatargas



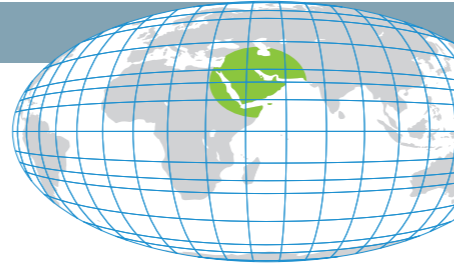

Qatargas 3, Qatargas 4

Client (Qatargas 3) :
Qatar Liquefied Gas Company Limited (3)

Year of Completion :
6th LNG Train EPC 2010
7th LNG Train EPC 2010
6th LNG Train FEED 2005
7th LNG Train FEED 2005

Annual Production Capacity :
7.8 MTPA of LNG x 2 Trains

Natural-Gas Liquefaction :
APCI AP – X process

Client (Qatargas 4) :
Qatar Liquefied Gas Company Limited (4)

Year of Completion :
7th LNG Train EPC 2010

Annual Production Capacity :
7.8 MTPA of LNG

Natural-Gas Liquefaction :
APCI AP – X process

Chiyoda Technip Joint Venture (CTJV), signed a contract for the Engineering, Procurement and Construction for two of the world's largest LNG trains with Qatar Liquefied Gas Company Limited (3) (Qatargas 3) and the sponsors of the Qatargas 4 Project (Qatargas 4). Chiyoda also performed the Front End Engineering and Design (FEED) work for Qatargas Train 6 and Train 7.

Trains 6 and 7, each with capacity of 7.8 mtpa of LNG, were constructed adjacent to Trains 4 and 5, executed by the CTJV within the framework of the contract signed with Qatargas 2.

By completion of Qatargas 3 and Qatargas 4, Qatar will be the world's largest LNG producer, with a combined production capacity of 77 mtpa.



Courtesy of Qatargas Operating Company Limited

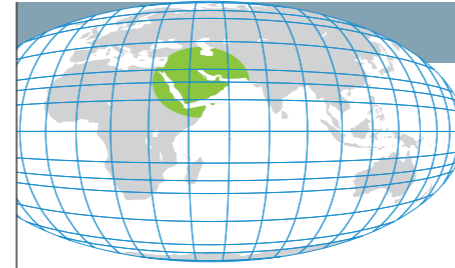

RasGas

Chiyoda started its history of work for RasGas in January 1994 with the FEED work for the 1st and 2nd trains, each train having a capacity of 3.3 mtpa. Subsequent to this FEED work, Chiyoda was awarded the FEED contracts for the 3rd & 4th Trains in 1999, each train with a capacity of 4,700,000 T/Y. In 2004, the 5th Train with capacity of 4.7 mtpa. The FEED work for 6th & 7th Trains was also awarded to Chiyoda in 2004, with a capacity of 7.8 mtpa each - the largest single trains ever designed in the world.

Chiyoda's successful experience began with RasGas Projects and it rapidly established itself as the best reliable contractor.



Courtesy of RasGas



Client :
RasGas Company Limited
Ras Laffan Liquefied Natural Gas Company Limited

Year of Completion :
6th & 7th LNG Trains (FEED) 2004
5th LNG Train (FEED) 2004
NGL Recovery Project (FEED) 2002
3rd & 4th LNG Trains (FEED) 2000
Off Shore Facilities 1998
1st & 2nd LNG Trains (FEED) 1995

Annual Production Capacity :
3.3 MTPA of LNG

Natural-Gas Liquefaction :
APCI C₃-MR process
APCI AP-X process

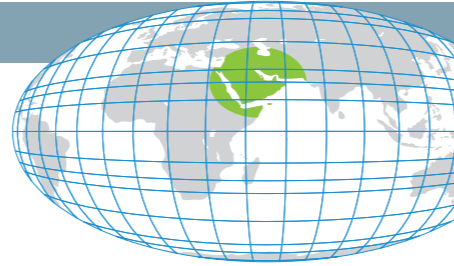

RasGas II

Client :
Ras Laffan Liquefied Natural Gas Company Limited (II)

Year of Completion :
5th LNG Train 2006
4th LNG Train 2005
3rd LNG Train 2003

Annual Production Capacity :
4.7 MTPA of LNG x 3 Trains

Natural-Gas Liquefaction :
APCI C₃-MR process

After successful execution of FEED work, the Engineering, Procurement and Construction (EPC) contract of 3rd train was awarded to the joint venture of Chiyoda, Mitsui, Snamprogetti and Almana (CMS&A) in 2001, 4th train in 2002, and the 5th train in June 2004. The 3rd train was completed in December 2003 with a remarkable fast-track delivery schedule of 33 months. Chiyoda also achieved a safety record of 21,500,000 man-hours with No Lost Time Incident (NLTI) in February 2004. Chiyoda successfully completed the 4th train in 2004 and it is in operation at full capacity. In November 2006, the 5th train was completed in just 28 months, a record for the fastest construction of an LNG plant that uses the APCI process.

Through a number of successful past and current experiences in the project execution under the gas value chain in Qatar, Chiyoda has become familiar with the regional conditions in Ras Laffan Industrial Area and Qatar. With this knowledge and experience, Chiyoda can best serve the client as a total solution provider to successfully materialize the planned venture.



Courtesy of RasGas



Courtesy of RasGas



RasGas 3

Chiyoda, as the leader of the joint venture with Technip France, signed a contract with the Ras Laffan Liquefied Natural Gas Company Limited (3) (RasGas 3) for the Engineering, Procurement and Construction (EPC) of RasGas Onshore Expansion Project Trains 6 & 7. Front End Engineering and Design (FEED) work was also performed by Chiyoda. The Trains 6 & 7, each designed to produce 7.8 mtpa of LNG, were started up for production in 2009.

The new LNG trains were constructed in Ras Laffan Industrial City where Chiyoda completed the existing RasGas Trains 3, 4 and 5 for RasGas II.



Client :
Ras Laffan Liquefied Natural Gas Company Limited (3)

Year of Completion :
6th LNG Train EPC 2009
7th LNG Train EPC 2009
6th LNG Train FEED 2005
7th LNG Train FEED 2005

Annual Production Capacity :
7.8 MTPA of LNG x 2 Trains

Natural-Gas Liquefaction :
APCI AP-X process

©RasGas Company Limited



©RasGas Company Limited



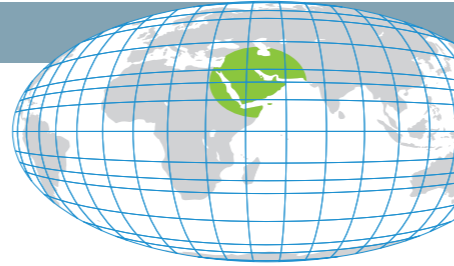

OMAN LNG

Client :
Oman LNG L.L.C.

Year of Completion :
1st & 2nd LNG Train 2000

Annual Production Capacity :
3.3 MTPA of LNG x 2 Trains

Natural-Gas Liquefaction :
APCI C₃-MR process

A two-train "grassroots" LNG complex with a single train capacity of 3.3 mtpa was successfully completed at Qalhat, 200 km south of Muscat in the Sultanate of Oman, situated away from the Straits of Hormuz and on the edge of the Arabian Peninsula. Chiyoda-Foster Wheeler and Company L.L.C. (CFW L.L.C.) was awarded the EPC contract in November 1996 for the Oman LNG Project and both trains were completed well ahead of the contractual schedule. Engineering, Procurement and Construction / commissioning planning activities including ECA based project financing services were carried out by one integrated task force at Chiyoda-Foster Wheeler (CFW) Partnership established in Reading, U.K.



Courtesy of Oman LNG



Courtesy of Oman LNG

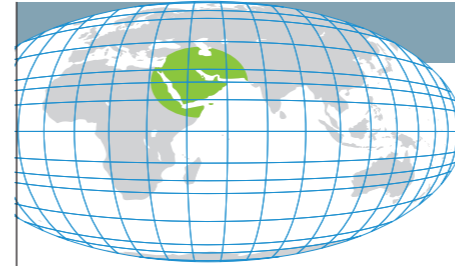

QALHAT LNG

Client :
Qalhat LNG S.A.O.C.

Year of Completion :
Qalhat LNG Train 2005

Annual Production Capacity :
3.3 MTPA of LNG

Natural-Gas Liquefaction :
APCI C₃-MR process

Chiyoda, with its JV partner Foster Wheeler Energy Limited, was awarded a contract in 2003 by the Government of the Sultanate of Oman, represented by the Ministry of Oil and Gas. The contract includes the Engineering, Procurement and Construction (EPC) of a LNG train at Qalhat, 200 km south of Muscat. The capacity of the new LNG train is 3.3 mtpa and it has been built adjacent to the existing Oman LNG Complex in Qalhat, where two identical LNG trains, each with a capacity of 3.3 mtpa have been operating since early 2000.



Courtesy of Qalhat LNG



Ready For Start-Up (RFSU) on this project was achieved 33.43 months after the contract award, 3 weeks earlier than the original plan, while a record of 20 million man-hour was accumulated without any Loss Time Incident since the contract started.

The Start-up team of the Q LNG train achieved LNG production in the world record of 9 days 3 hours after RFSU by applying Shell's Flawless Start-up concept. The first cargo was shipped 30 days after RFSU.



Courtesy of Qalhat LNG



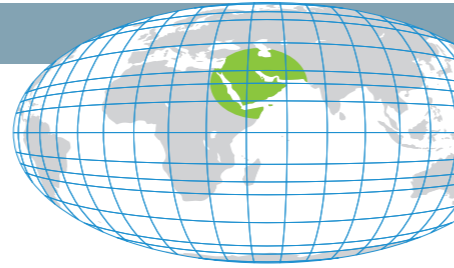

ADGAS

Client :
Abu Dhabi Gas Liquefaction Co., Ltd.
(ADGAS)

Year of Completion :
LPG-4 (FEED) 2002
BOG Recovery Project (FEED) 2001
3rd LNG Train 1994
LNG Plant Expansion (FEED) 1991
1st & 2nd LNG Train 1976

Annual Production Capacity :
4.7 MTPA of LNG
1.1 MTPA of LPG
0.3 MTPA of Gasoline
0.33 MTPA of Sulfur

Natural-Gas Liquefaction :
APCI C₃-MR process

Das Island is located offshore of Abu Dhabi in the United Arab Emirates. The Abu Dhabi Gas Liquefaction Co., Ltd. (ADGAS) awarded the FEED contract to Chiyoda with its joint venture partner, Bechtel in 1970. EPC contract for the LNG plant having the capacity of 1.1 mtpa x 2 trains as well as related storage, utilities and loading facilities was awarded to the Joint Venture of Chiyoda and Bechtel in 1973.



Chiyoda was awarded the FEED contract in 1990 and subsequently the EPC contract in 1991 for the 3rd LNG train having the capacity of 2.5 mtpa. To execute this project, Chiyoda's high-caliber project team carefully applied its know-how and database which were delivered from hands-on experience in previous LNG and other large-scale projects worldwide.

With the application of an ISO9000-based quality management system, innovative design and value engineering were implemented to cope with the constraints and formidable logistics conditions in the area. The 3rd LNG Train was completed in May 1994 in record-breaking 30 months with an excellent safety record. Chiyoda also executed the FEED contract on BOG Recovery Project in 2001 and LPG-4 train in 2002.

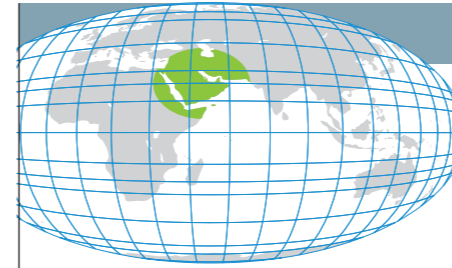

North Field East Onshore Facilities Project

After successful execution of the FEED work, Chiyoda, with its joint venture partner Technip France, signed in February 2021 the Letter of Award with Qatar Petroleum for Engineering, Procurement and Construction (EPC) of North Field East (NFE) Project Onshore Facilities. The scope of work includes 4 new natural gas liquefaction trains in Ras Laffan, Qatar. The production capacity of each new LNG train is 8.0 mtpa.



The NFE project includes, a CCS (Carbon Capture Storage) system and other environmental initiatives which together can reduce the greenhouse gas by 25% compared with existing LNG plants in Qatar. By successful completion the project, Chiyoda will contribute to the stable supply of environmentally friendly LNG.

The expansion will produce approximately 33 mtpa of LNG, increasing Qatar's production from 77 mtpa to 110 mtpa.

Client :
Qatar Petroleum

Annual Production Capacity :
8.0 MTPA of LNG x 4 Trains

Natural-Gas Liquefaction :
APCI AP-X process

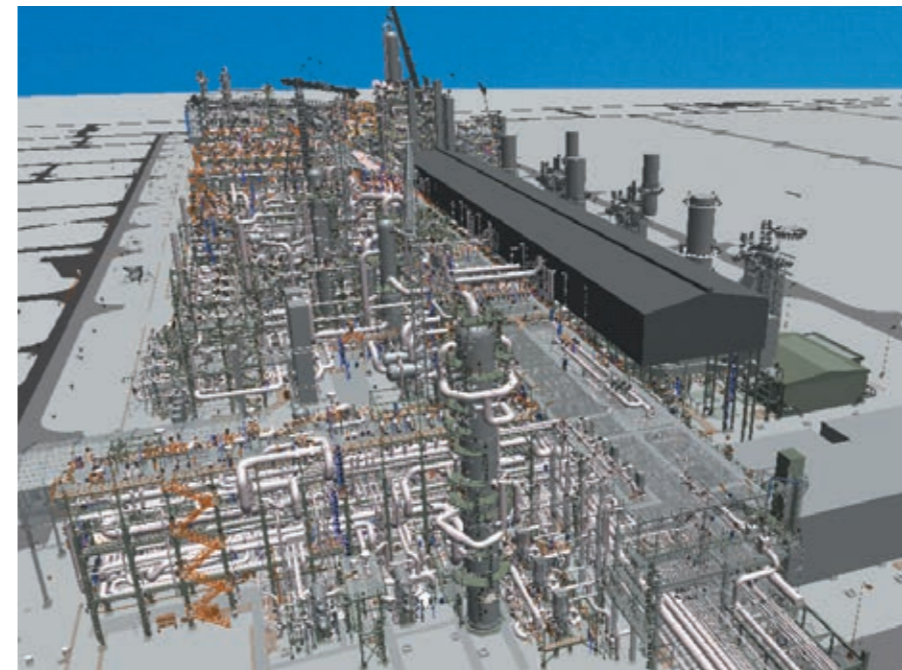

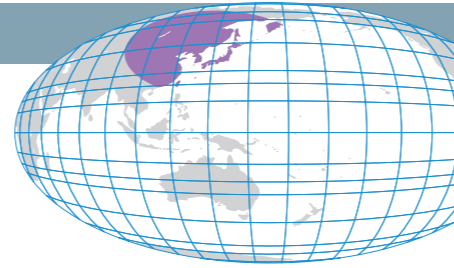

Sakhalin II

Client :
Sakhalin Energy Investment Company Ltd. (SEIC)

Year of Completion :
Train-2 2008
Train-1 2008
Oil Export Terminal and Utility 2006

Annual Production Capacity :
4.8 MTPA of LNG x 2 Trains

Natural-Gas Liquefaction :
Shell DMR process

Chiyoda, along with Toyo Engineering Corporation (TEC) and the Russian partners, NIPIgaspererabotka and Khimenergo, signed the EPC contract with Sakhalin Energy Investment Company Ltd. (SEIC) in June 2003 for a grassroots LNG plant complex that was a part of the Sakhalin II Project.



SEIC is owned by Gazprom (50%+1share), Shell Sakhalin Holdings B.V. (27.5 %-1share), Mitsui Sakhalin Holdings B.V. (12.5%) and Diamond Gas Sakhalin B.V. (10 %).

The project construction site is located at Prigorodnoye on a southern part of Sakhalin Island in Russian Federation. The site is about 160 km from Wakkanai, the northern most tip of the Japanese island, Hokkaido. The plant consists of two LNG trains, each with a production capacity of 4.8 mtpa. Both trains started operation in 2009. Shell's Double Mixed Refrigerant (DMR) liquefaction process is adopted for the first time in a base-load LNG plant. The LNG plant also includes two 100,000 cubic meter LNG tanks and a LNG loading jetty.

Chiyoda performed project specification (PS) work in a joint venture with Fluor Daniel of the Netherlands and NIPIgaspererabotka.

This first LNG project in Russia, which has the world's largest natural gas reserves, has been operating since early 2009 and has become the cornerstone of future projects in the country.

Courtesy of Sakhalin Energy Investment Company

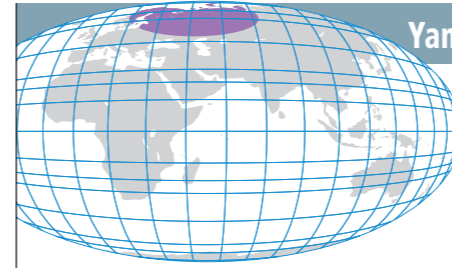

Yamal LNG Project

In 2014 Chiyoda Corporation, together with Technip of France and JGC of Japan (TJC JV), was awarded a contract by JSC Yamal LNG to build their LNG Plant in Sabetta, which is located within the Arctic Circle in Russia's Yamal-Nenets Autonomous District.



The Contract is for the engineering, procurement, supply, construction, and commissioning (EPSCC) of an onshore LNG processing facility in Sabetta to liquefy gas from the South Tambey gas condensate field on the Yamal Peninsula. The plant has a production capacity of 16.5 mtpa (5.5 mtpa x 3 trains) of LNG.

Yamal LNG is jointly owned by NOVATEK (50.1%), TOTAL S.A. (20%), China National Oil and Gas Exploration and Development Corporation (20%) and Silk Road Fund (9.9%).

A very distinctive aspect of this project is the fully modularized construction strategy, that minimized onshore construction activities at the construction site in Sabetta. TJC JV utilized several fabrication yards to support the planned production of approximately 500 thousand tons of modules, with a high level of project management, schedule supervision, and engineering skills.

This project was successfully completed in 2018 and Chiyoda was honored to receive the Engineering Distinguished Service Award 2018 from the Engineering Advancement Association of Japan (ENNA).

Client :
JSC Yamal LNG

Year of Completion :
Train-1 2017
Train-2 2018
Train-3 2019

Annual Production Capacity :
5.5 MTPA of LNG x 3 Trains

Natural-Gas Liquefaction :
APCI C₃-MR process

Courtesy of JSC Yamal LNG





PERTAMINA

Client :

PERTAMINA (Perusahaan Pertambangan Minyak Dan Gas Bumi Negara)
P.T. Badak NGL

Year of Completion :

- Badak LNG Reliability Enhancement (BLRE) 2002
- Train- I Bontang LNG Expansion (FEED) 2001
- No. 3 LNG Loading Dock Project 1998
- Train-G 1997
- Train-F 1993
- Train-E 1989

Annual Production Capacity :

22.5 MTPA of LNG
1 MTPA of LPG
1,150,000 barrels of Condensate

Natural-Gas Liquefaction :

APCI C₃-MR process

On the east coast of Kalimantan Island in Indonesia, facing the Makassar Strait, large scale LNG plants have been constructed to utilize Badak field gas. P.T. Badak NGL is now operating eight LNG production trains having a total annual output of about 22.5 million tons.



PERTAMINA, the plant owner, awarded Chiyoda and Mitsubishi a contract to expand the plant by adding one more LNG-production train (Train-E) and four LPG-extraction trains followed by awarding Inti Karya Persada Teknik (IKPT) and Chiyoda two other LNG-production trains (Train-F&G).

PERTAMINA LNG/LPG Projects (PLL) was the project manager, supervising construction and commissioning. IKPT and Chiyoda were responsible for design, engineering, procurement and construction for the plant's expansion as well as related storage, utilities and loading facilities. Train-F was completed in 32 months from the award of contract on a fast-track basis. Furthermore, Train-G was completed in November 1997, one month ahead of schedule. No. 3 loading dock / LPG storage project was completed in 1998, 3 weeks ahead. Also, Badak LNG Reliability Enhancement for P.T. Badak NGL was completed in September 2002, half a month ahead of schedule.



PERTAMINA

On the northern coast of Sumatra Island in Indonesia, facing the entrance of Malaka Strait, LNG plants were constructed in order to utilize Arun field gas. P.T. Arun Natural Gas Liquefaction Co. is operating six LNG production trains with a total annual output of 10.5 million tons.



A contract to expand the plant by adding two more LNG production trains with 1.75 mtpa of capacity each was awarded to Chiyoda and Mitsubishi by PERTAMINA Organization for LNG Expansion (POLE) was the project manager who supervised construction and commissioning.

The Chiyoda-Mitsubishi joint venture was responsible for design, engineering, procurement and construction of the expanded plant as well as related storage, utilities and loading facilities.

Client :

PERTAMINA (Perusahaan Pertambangan Minyak Dan Gas Bumi Negara)

Year of Completion :

- 5th LNG Train 1984
- 4th LNG Train 1983

Annual Production Capacity :

1.75 MTPA of LNG x 2 Trains

Natural-Gas Liquefaction :

APCI C₃-MR process



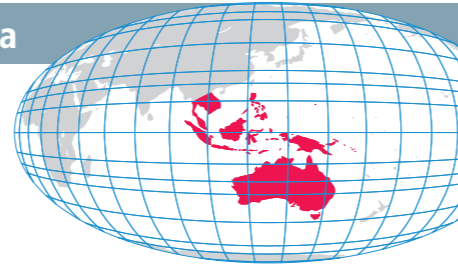

PNG LNG Project

Client :
ExxonMobil PNG Limited

Year of Completion :
1st train EPC 2013
2nd train EPC 2014

Annual Production Capacity :
3.45 MTPA of LNG x 2 Trains

Natural-Gas Liquefaction :
APCI C₃-MR process

Chiyoda, as the leader of a joint venture with JGC Corporation (CJ JV), completed the first LNG plant in Papua New Guinea (PNG), including facilities for inlet processing, treating, liquefaction, storage, and ship loading.

The first train was turned over to the client on 31 December 2013 and the second on 31 March 2014, with each train being completed on time and within budget.

The Contract for the Engineering Procurement and Construction (EPC) was awarded in December 2009 for a plant which is designed to produce up to 6.9 mtpa of LNG from two trains, half of which will be exported to Japan. It took only 67 months to complete this project from the time that Chiyoda Corporation started the Front End Engineering Design (FEED) in September 2008.

Owing to our technological strengths and accumulated management experience in LNG projects, CJ JV was able to achieve 6.5 million man-hours of No Loss Time Incidents (NLT) in May 2014, which bettered Chiyoda's past record on LNG Projects. CJ JV was also honored to receive the Engineering Distinguished Service Award 2014 from the Engineering Advancement Association of Japan (ENAA).



Courtesy of ExxonMobil PNG Limited



Courtesy of ExxonMobil PNG Limited



Ichthys LNG Project

Following participation in FEED activities from January 2009, Chiyoda together with its joint venture partners, JGC of Japan and KBR of USA (JKC JV), was awarded the contract for Ichthys Onshore LNG Facilities by Ichthys LNG Pty Ltd on February 9, 2012.

The contract was for the engineering, procurement and construction (EPC) of an onshore LNG processing facility in Darwin to liquefy gas from the Ichthys gas-condensate field in the Browse Basin, offshore Western Australia. The LNG plant has a production capacity of 8.9 mtpa (4.45 mtpa x 2 trains) of LNG, 1.6 mtpa of LPG along with 100,000 barrels of condensate per day at peak.

The overall Ichthys LNG Project is an integrated natural gas field development project being executed by the INPEX group, Total group and Japanese utility companies. As of October 2017, the participating interests in the Ichthys LNG Project are affiliates of INPEX group companies (62.245%), Total group companies (30%), CPC (2.625%), Tokyo Gas (1.575%), Osaka Gas (1.200%), Kansai Electric Power (1.200%), JERA (0.735%) and Toho Gas (0.420%).

A unique and challenging aspect of the project is the fully modular construction strategy that minimized onshore construction activities at the construction site in Darwin. JKC JV utilized several fabrication yards to support the planned production of 180,000 tons of modules which requires a high-level of project management, schedule control and engineering skills.

Plant overview photo for of the INPEX-operated Ichthys LNG onshore LNG processing facilities, in Darwin Australia. project (Courtesy of INPEX Operations Australia Pty Ltd)

Plant overview of the INPEX-operated Ichthys LNG onshore processing facilities, in Darwin Australia.



Courtesy of INPEX Operations Australia Pty Ltd.

Client :
INPEX Operations Australia Pty Ltd.

Annual Production Capacity :
4.45 MTPA of LNG x 2 Trains
1.6 MTPA of LPG
100,000 barrels per day of Condensate (at peak)

Natural-Gas Liquefaction :
APCI C₃-MR process





Tanggung Expansion Project (TEP)

Client :
BP Berau Ltd.

Year of Completion :
(non-disclosable)

Annual Production Capacity :
3.8 MTPA of LNG x 1 train

Natural-Gas Liquefaction :
APCI C₃-MR process

Chiyoda together with Tripatra (Indonesia), Saipem (Italy) and Suluh Ardhi Engineering (Indonesia) was awarded a contract with BP Berau Ltd. (as the operator of Tangguh Production Sharing Contractors) for the onshore EPC contract for Tangguh Expansion Project (Tangguh LNG Train 3) in August 2016.



Tangguh LNG Train-3 with a liquefaction capacity of 3.8 mtpa will be built at the Tangguh site, which is located in western Papua Province of Indonesia, in addition to the existing Train-1 & 2 (3.8 mtpa x 2 Trains).

Regarding the product from Train-3, 2.8 mtpa will be sold to Indonesian Domestic market and 1.0 mtpa will be sold to Kansai Electric Power Co. Inc.

Tangguh LNG Train-3 Project, Kick-off Meeting held on August 31, 2016



GNL 3Z Project (Arzew LNG Train)

Saipem/Chiyoda joint venture was awarded a new onshore contract for Sonatrach's GNL3Z (Arzew LNG Train) Project in July 2008.

This contract encompasses engineering, procurement and construction of single-train 4.7 mtpa natural gas liquefaction plant.

This new plant enabled Algeria, Africa's largest gas provider, to boost-up its export of natural gas to 85 billion cubic meters per year by end 2014.

Based on Chiyoda's extensive experience in LNG projects, LNG plant operability and maintainability were fully reflected in the new project design. Saipem and Chiyoda also provided operator training.



Client :
Société Nationale pour la Recherche, la Production, le Transport et la Commercialisation des Hydrocarbures (SONATRACH SPA)

Year of Completion :
EPC 2015

Annual Production Capacity :
4.7 MTPA of LNG x 1 train

Natural-Gas Liquefaction :
APCI C₃-MR process

Courtesy of Sonatrach



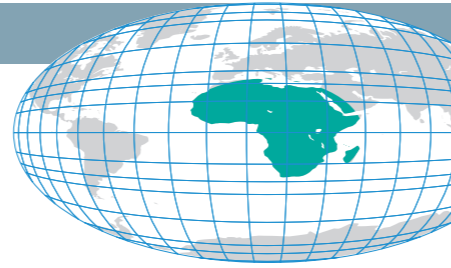

Offshore Area 1 Mozambique LNG Project

Client :

Total E&P Mozambique Area 1 Ltd., ENH Rovuma Área Um, S.A, Mitsui E&P Mozambique Area1 Ltd., ONGC Videsh Ltd., Beas Rovuma Energy Mozambique Ltd., BPRL Ventures Mozambique B.V. and PTTEP Mozambique Area 1 Ltd.

Annual Production Capacity:

6.44 MTPA of LNG x 2 trains

Natural-Gas Liquefaction:

APCI C3-MR process

On June 5, 2019, Mirai Engineering Italy S.R.L. (MEI), an Italy-based subsidiary of Chiyoda Corporation, in Joint Venture with Saipem S.p.A. and McDermott International, reached agreement with Area 1 Concessionaires on an EPC Contract to engineer and construct an onshore LNG project in Mozambique. Saipem and McDermott, operating as CCSJV (the Joint Venture incorporated in Italy to execute the LNG project) will deliver the project from their HQ in Milan, Italy. MEI will provide specified technical support to CCS JV for the LNG project.



The contract has been executed by Anadarko Moçambique Area 1, Lda., a wholly owned subsidiary of Anadarko Petroleum Corporation, which operates Offshore Area 1 and acts as front-runner of a Venture including other leaders in the energy sector, such as ENH Rovuma Área Um, S.A, Mitsui E&P Mozambique Area1 Ltd., ONGC Videsh Ltd., Beas Rovuma Energy Mozambique Limited, BPRL Ventures Mozambique B.V. and PTTEP Mozambique Area 1 Limited.

The LNG Project will be Mozambique's first onshore LNG development, initially consisting of two LNG trains with total nameplate capacity of 12.88 mtpa, as well as all necessary associated infrastructure, storage tanks and export jetty facilities. The official declaration of FID was made at a sanctioning on June 18, 2019.

Courtesy of Total E&P Mozambique Area 1 Ltd.

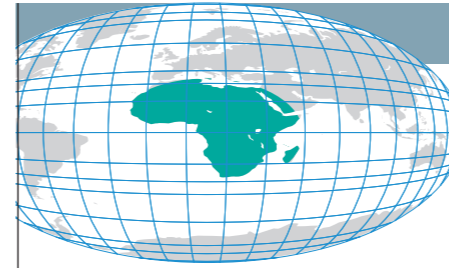

Nigeria LNG Train 7

SCD Joint Venture, comprising of Saipem, Daewoo and Chiyoda, was awarded contracts for the engineering, procurement, construction and commissioning of the Nigeria LNG Limited (NLNG) Train 7 project in May 2020.



The Train 7 project consists of the construction of a complete LNG train and a common liquefaction unit, with a total capacity of approximately eight (8) MTPA.

The NLNG plant is located at Bonny Island, approx. 40 km south of Port Harcourt in Rivers State, Nigeria.

The SCD Joint Venture also conducted the Front End Engineering and Design and preparation of the EPC proposal work for the project from July 2018, leading up to final award of the contracts. The project is expected to increase NLNG's existing LNG plant capacity to 30 MTPA upon completion.

Client :

Nigeria LNG Ltd.

Year of Completion :

(2025)

Annual Production Capacity :

8.0 MTPA of LNG

Natural-Gas Liquefaction :

APCI C3-MR process



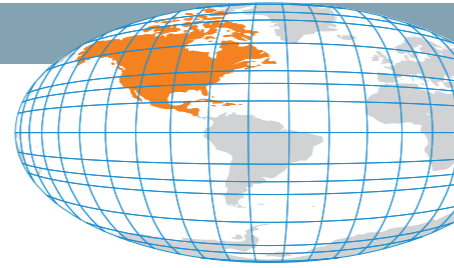

Freeport LNG Export Project

Operator:

Train 1: FLNG Liquefaction, LLC
 Train 2: FLNG Liquefaction 2, LLC
 Train 3: FLNG Liquefaction 3, LLC

Year of Completion :

Train-1 2019
 Train-2 2020
 Train-3 2020

Annual Production Capacity :

4.64 MTPA of LNG x 3 Trains

Natural-Gas Liquefaction :

APCI C₃-MR process

On December 10, 2013, FLNG Liquefaction, LLC, and FLNG Liquefaction 2, LLC, have awarded the contract for Engineering, Procurement and Construction (“EPC”) for the Freeport LNG Project to the CB&I and Zachry Industrial, Inc., Joint Venture (“CZ JV”). Chiyoda International Corporation (“CIC”), a 100% U.S. subsidiary company of Chiyoda Corporation, executed the EPC work with CZ JV. In March 2015, FLNG Liquefaction 3, LLC have awarded the contract for the EPC of the third train of three train natural gas liquefaction and export facility to the joint venture between CIC, CB&I and Zachry Industrial Inc.



Freeport LNG Project includes three liquefaction trains with a total nameplate capacity of 13.9 mtpa and CZ JV was awarded EPC contracts for the first two trains (4.64 mtpa each) in the first phase of the project development.

The owner of train 1, FLNG Liquefaction, LLC, is comprised of Freeport LNG (50%), a U.S. subsidiary of Chubu Electric (25%) and a U.S. subsidiary of Osaka Gas (25%). For Train 2, Freeport LNG and IFM Investors are equity holders in FLNG Liquefaction 2, LLC. For Train 3, Freeport LNG is the entire equity holder.

The U.S. has an opportunity to expand its participation in the global market for natural gas, as the country has more than one hundred years’ worth of gas reserves and is well positioned to contribute to meeting the growing global demand for gas. Freeport LNG’s gas liquefaction and export of LNG represent a long-term economic stimulus to the nation’s natural gas-producing regions, including Texas and the entire Gulf Coast.) This is the first EPC work involving an LNG project in the U.S. for Chiyoda Group.

Freeport LNG was Chiyoda Group’s first EPC project in the U.S. By overcoming various technical challenges, Chiyoda with partners successfully delivered the first world-scale electric LNG (eLNG) plant. Three 75 MW motors drive the refrigerant compressors per train. eLNG is one of key solutions for greener LNG.

Courtesy of Freeport LNG Development, L.P.*



Cameron Liquefaction Project

Chiyoda International Corporation, a U.S. based wholly-owned subsidiary of Chiyoda, with its JV partner CB&I, was awarded a contract by Cameron LNG, LLC (Cameron LNG) on March 17, 2014, to build the Cameron Liquefaction Project, in Hackberry, LA, near the Gulf of Mexico.



The scope of work includes engineering, procurement and construction (EPC) for the addition of natural gas liquefaction and export facilities to the existing LNG regasification facility. The project will comprise three liquefaction trains with a nameplate capacity of approximately 13.5 mtpa of LNG.

Cameron LNG is jointly owned by Sempra LNG (50.2%), Total (16.6%), Mitsui & Co., Ltd. (16.6%) and Japan LNG Investment, LLC (16.6%), a company jointly owned by Mitsubishi Corporation and Nippon Yusen Kabushiki Kaisha (NYK).

The project was the second natural gas liquefaction-export project in the U.S. authorized by the Federal Energy Regulatory Commission (FERC) for the construction and operation of facilities, and has been authorized by the Department of Energy (DOE) to export domestically-produced LNG to countries that do not have a free-trade agreement (FTA) with the U.S.

The project will create approximately 3,000 jobs directly in Southwest Louisiana, as well as hundreds of additional off-site jobs to support the design, fabrication and construction of the facilities.

Cameron LNG, Louisiana State, USA



Client :

Cameron LNG, LLC

Year of Completion :

Train-1 2019
 Train-2 2020
 Train-3 2020

Annual Production Capacity :

4.5 MTPA of LNG x 3 Trains

Natural-Gas Liquefaction :

APCI C₃-MR Process



Courtesy of Cameron LNG, LLC

North America

Sabine Pass, Texas, U.S.A.

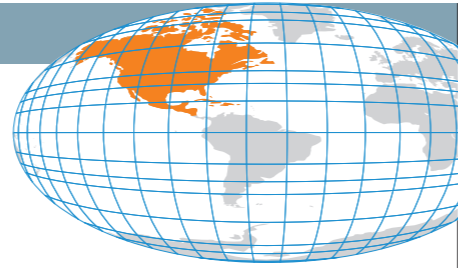

Golden Pass LNG Export Project

Client :
Golden Pass LNG

Annual Production Capacity :
approximately 5.2 MTPA of LNG
x 3 Trains

Natural-Gas Liquefaction :
APCI C₃-MR Process

The Golden Pass LNG Export Project in Sabine Pass, Texas USA, converts the existing LNG receiving facilities into a new natural gas liquefaction plant with a capacity of around 16 mtpa (three liquefaction trains, approx. 5.2 mtpa each). Chiyoda executed the Front End Engineering Design (FEED) work, and will complete the Engineering, Procurement and Construction (EPC) phase together with its joint venture partners, Zachry and McDermott.

The Client, Golden Pass LNG, is owned by affiliates of Qatar Petroleum and ExxonMobil. Chiyoda has unrivalled global FEED and EPC LNG project experience, including six (6) LNG trains of 7.8 mtpa capacity in Qatar, the largest ever constructed, and continues to strengthen the current close working relationship with Qatar Petroleum and ExxonMobil.

By successfully completing the project and adding to Chiyoda's two (2) large ongoing LNG projects on the Gulf Coast, Chiyoda will contribute to the stable supply of environmentally friendly LNG worldwide from the USA.



Courtesy of Golden Pass Products LLC

Santos Basin, Offshore Brazil

South America



Petrobras FLNG

Chiyoda with its partner SBM Offshore was awarded a Front End Engineering Design contract from Petrobras Netherlands B.V. for Floating LNG (FLNG) Santos Basin Project conducted by the joint venture formed by Petrobras Netherlands, BG Group, Repsol and Galp Energia to develop the Pre-salt reservoirs located deepwater in the Santos Basin, offshore Brazil.



Client :
Petrobras Netherlands B.V., BG Group, Repsol, Galp Energia

Year of Completion :
FEED 2010

Annual Production Capacity :
2.7 MTPA of LNG

The FLNG concept was studied as a means to handle the associated gas that will be produced from the oil and gas floating production storage and offloading facilities (FPSOs) to be installed in the same area in the coming years. The FLNG will process and liquefy natural gas, butane, propane and condensate with processing capacity of up to 14 million cubic meters per day. The processed LNG will be transported to the consumer market via gas carrier vessels and regasification terminals in Brazil. The FLNG will be an important source of gas supply to the Brazilian market and at the same time makes it possible to export the processed LNG during periods of low domestic demand.

Chiyoda and SBM Offshore will jointly seek to contribute and participate in the further development of the FLNG concept for the client ultimately leading to an opportunity of monetizing the massive Pre-salt gas reserves in the Santos Basin and creating a stable and flexible natural gas supply system in Brazil.

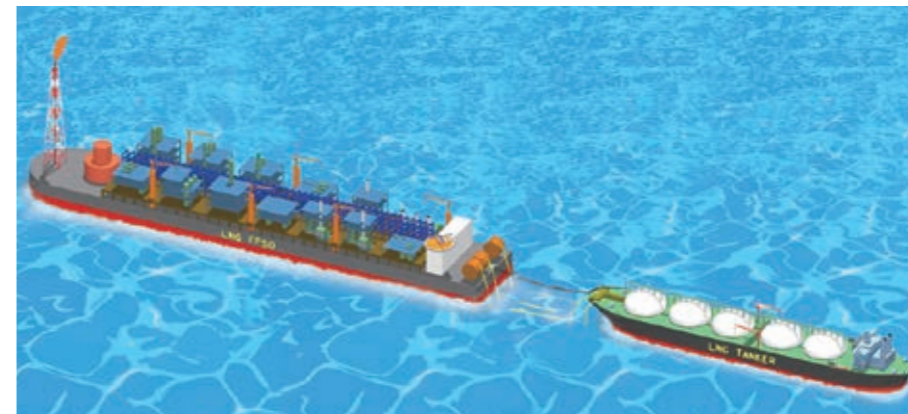

Chiyoda's Experience in Gas Processing Plant

Project Summary (Gas Processing)

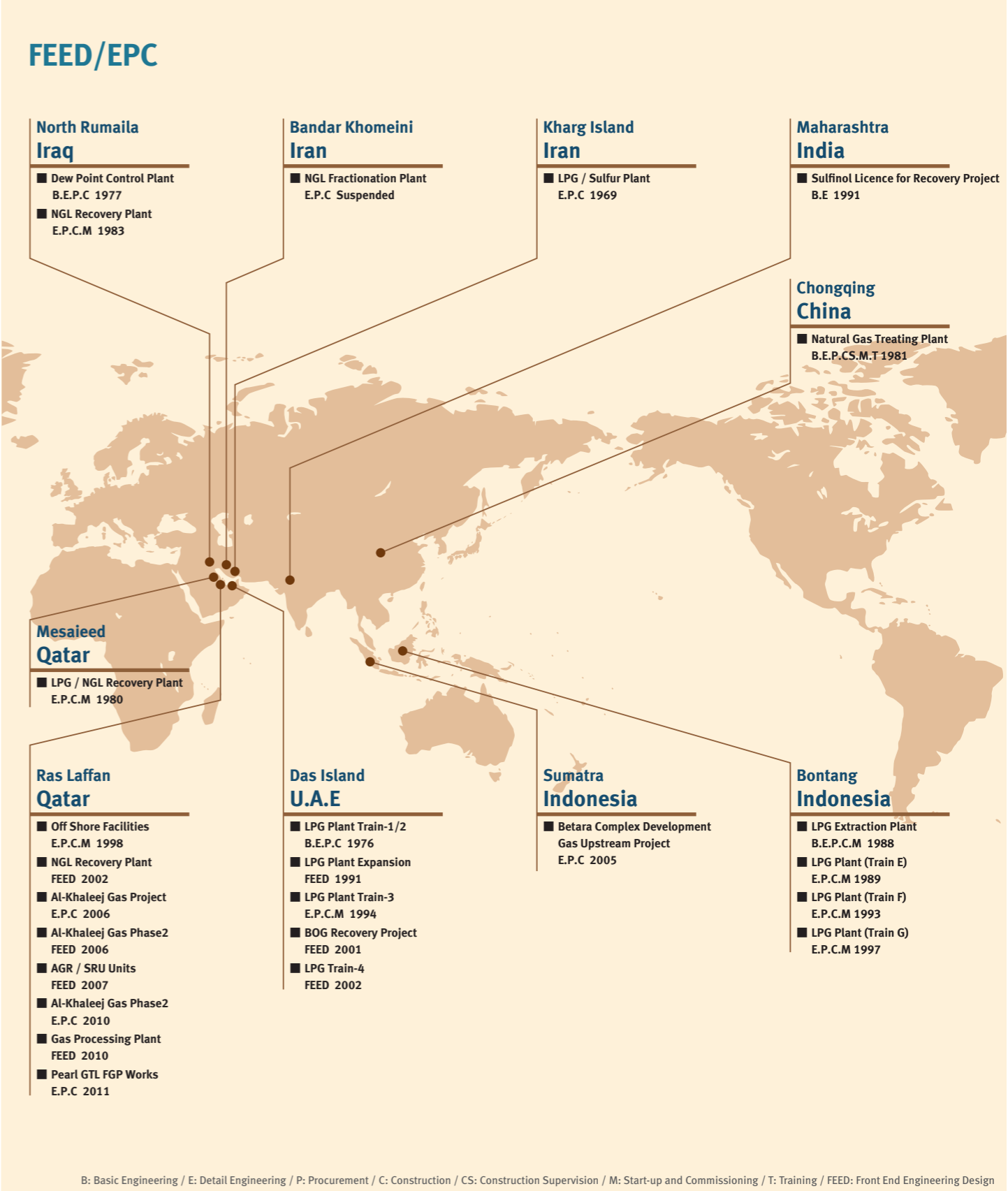

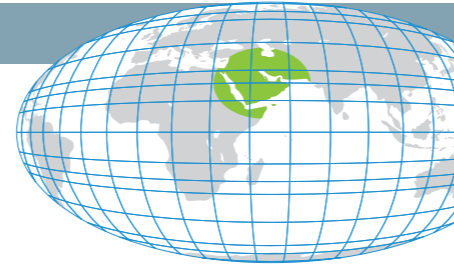

Pearl GTL Feed Gas Preparation Works

Client :
Qatar Shell GTL Limited

Year of Completion :
EPC 2011

Annual Production Capacity :
800 MTPA x 2 Trains

Chiyoda was awarded the contract from Qatar Shell GTL Limited for Engineering, Procurement and Construction (EPC) for the Feed Gas Preparation Works of the Pearl GTL Project. The gas processing unit has two trains with a capacity of 800 MSCFD each and a total of 1,600 MSCFD of natural gas (equivalent to 8 MTPA of LNG). The unit sends feed gas to the GTL core unit to produce 140,000 barrels per day of GTL products. The work is executed by a consortium of Chiyoda Corporation, as the leader, and Hyundai Heavy Industries.



The award to Chiyoda of a world class capacity plant is proof of the client's recognition of Chiyoda's reliability on quality plants. The most important contributing factor for high plant reliability is the implementation of Chiyoda's Reliability Program. In addition, Chiyoda's high technical capability and profound knowledge of the Ras Laffan Industrial City will lead to the success of the project.

The GTL plant will produce virtually sulfur free, clean liquid products and fuels that will contribute to cleaner air quality for cities around the world. Accordingly, various GTL projects are being planned worldwide and Chiyoda, by participating in this GTL project, has created a major milestone for future GTL projects.

Courtesy of Shell



Courtesy of Shell

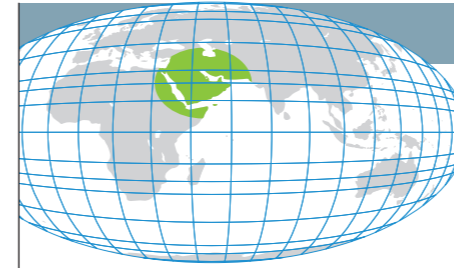

AKG-1/2

Chiyoda with its JV partners, Mitsui & Co., Ltd. and Snamprogetti & Co., W.L.L. (CMS&A), received an order in March 2003 from ExxonMobil Middle East Gas Marketing Ltd. for the construction of Al-Khaleej Gas Project Phase 1. The plant is located adjacent to the RasGas LNG trains in Ras Laffan, Qatar. Chiyoda was responsible for the design, engineering, procurement, construction and operator training. The plant was completed in 2006.



This project has provided a reliable sales gas supply to significant projects within the country since November 2005.

Chiyoda with its JV partner Technip was awarded the Engineering, Procurement and Construction contract from ExxonMobil Middle East Gas Marketing Ltd. for Al-Khaleej Gas Project Phase 2 (AKG-2). The project was to build a gas processing train, with the capability for ethane recovery, to produce 1,250 MSCFD of sales gas. The Front End Engineering and Design work was also executed by Chiyoda.

The sales gas has been distributed to the domestic market and contributes to the further development of the infrastructure of the Qatari industry.

AKG-2 benefitted from Chiyoda's extensive experience in Ras Laffan Industrial City, gas processing expertise and our Reliability Program.

(AKG-1)

Client :
ExxonMobil Middle East Gas Marketing Ltd.

Year of Completion :
2006

Annual Production Capacity :
Sales Gas 750 MMSCFD
• Propane
• Butane
• Condensate
• Ethane

Plant Features:

- Boiler (Package Boiler, Degreaser, BFW Pumps, etc.)
- TEG Package
- Pig Receiver
- Off-site Piperack
- Acid Gas Removal
- Dehydration
- Mercury Removal
- NGL Extraction
- Fractionation

(AKG-2)

Client :
ExxonMobil Middle East Gas Marketing Ltd.

Year of Completion :
EPC 2010
FEED 2005

Annual Production Capacity :
Sales Gas of 1,250 MSCFD
• Propane
• Butane
• Plant Condensate
• Ethane





Betara Complex Development Project

Client :
PetroChina International Jabung Ltd.

Year of Completion :
2005

Annual Production Capacity :
100 mmscfd of Sales Gas
25,000 BPD of NGL
15,200 BPD of LPG
9,930 BPD of Condensate

- Plant Features :**
- Betara Central Gas Processing Plant
 - NEB Gas Plant w/ Reinjection Compression
 - NEB / GEMAH CO₂ Extraction Plant
 - GEMAH Associated Gas Compression
 - NB / NEB Associated Gas Compression
 - GEMAH Raw Gas PL to NEB Gas Plant
 - NG NGL Fractionation Plant
 - NGL PL NEB Gas Plant to NG Fractionation Plant
 - PL Extension BMT to FPU (Butane)
 - PL NG Fractionation Plant to FPU (Propane)
 - Oil PL Extension BMT to Oil / Condensate FSO

The gas processing plant in the jungles of Indonesia's central Sumatra Island was newly completed in 2005 for PetroChina International Jabung Ltd. The Betara Complex Development Project delivers 100 mmscfd of sales gas to Singapore via pipelines and produces LPG and condensate for shipment via FSO.



Chiyoda Corporation undertook the Project in collaboration with its affiliate PT Chiyoda International Indonesia, the Singapore-based engineering firm SembCorp Engineers and Constructors Pte Ltd., and SembCorp's affiliate company PT Sempec Indonesia. The consortium of four companies engaged in the engineering, procurement and construction of the grassroots plant, which embraced central gas processing facilities, gas recovery facilities, over 200 km of pipelines, and offshore mooring facilities related to FSO offloading.



NGL Recovery Plant in Iraq

Client :
State Organization for Oil Projects

Year of Completion :
1983 (Mechanically completed)

Annual Production Capacity:
495 MMSCFD of sales gas
1,950,000 tons of NGL (C₃+)

- Plant Features :**
- Acid gas removal unit;
 - Selective sulfinol process
 - Dehydration unit;
 - TEG process / molecular-sieve process
 - Method of condensate recovery (NGL);
 - Chilling by external refrigeration of propane cycle

Chiyoda received an order in late 1979 from the State Organization for Oil Projects (SCOP) for the construction of an NGL recovery plant on a turnkey basis in North Rumaila. For this NGL recovery plant, Chiyoda handled basic design, engineering, procurement, construction, and training of operators.

Dew Point Control Plant in Iraq

Client :
State Organization for Oil Projects

Year of Completion :
1977

Annual Production Capacity:
194 MMSCFD of sales gas
180,000 tons of natural gasoline

- Plant Features :**
- Dew point control unit;
 - Refrigerated separation process by propane refrigeration
 - All skid mounted plant

The dew point control unit plays an important role in the transportation of natural gas by trunk line. In the North Rumaila district, about 50 kilometers north of Basra, Iraq, a dew point control unit built by Chiyoda is in operation. The natural gas treated by the plant is sent to the thermal power plant at Nassiriyah, about 200 kilometers northwest of Basra.

Natural Gas Treating Plant in China

Client :
China National Technical Import Corporation

Year of Completion :
1981

Annual Production Capacity:
140 MMSCFD of sales gas
90,000 tons of sulfur

- Plant Features :**
- Acid gas removal unit;
 - Sulfinol process
 - Dehydration unit;
 - TEG process
 - Sulfur recovery, Claus process
 - Tail gas treating;
 - SCOT process

Chiyoda received an order in November 1977 from the Natural Technical Import Corporation of the People's Republic of China for the construction of a natural gas treating plant having a capacity of 4,000,000 Nm³/day. Chiyoda was responsible for design, engineering, procurement, supervision of construction and operator training. The plant removes sulfur from natural gas and exports treated gas as fuel and raw material for fertilizers.



Other Gas Processing Experience

LPG/NGL Recovery Plant in Qatar

Client :
Qatar General Petroleum Corporation

Year of Completion :
1980

Annual Production Capacity:
660,000 tons of LPG
300,000 tons of natural gasoline

Plant Features :
Gas treating;
ADIP process
Dehydration;
EG injection
LPG recovery;
Refrigerated absorption and fractionation
LPG treating;
ADIP and molecular sieves
Refrigeration, Propane refrigeration
Type of LPG storage tanks;
Above ground, double integrity tanks

Chiyoda received an order from Shell for the construction of an NGL recovery and fractionation plant, which Qatar General Petroleum Corporation (QGPC) decided to build in the Mesaieed district. The plant processes the associated gas from Qatar's three offshore fields-Idd E1 Shargi, Maydan Mahzam and Bul Hansine-and converts it into precious commercial products including propane, butane, gasoline, methane-rich gas, and ethane-rich gas. Propane, butane and gasoline are exported, while methane is fed into the country's gas distribution network.

Produced LPG is to be stored in double integrity tanks designed by Shell with special consideration given to a particularly high reliability.



LPG/Sulfur Plant in Iran

Client :
Kharg Chemical Company, Ltd.

Year of Completion :
1969

Annual Production Capacity:
200,000 tons of LPG
20,000 tons of natural gasoline
200,000 tons of sulfur

Plant Features :
Acid-gas removal unit;
DEA process
Dehydration unit;
TEG process
LPG recovery system;
Absorption with lean oil by external refrigeration of propane cycle
Sulfur recovery;
Claus process
Type of LPG storage tanks;
Above ground, single wall tanks

Kharg Island in the Persian Gulf, once a barren coral island, is now a modern export outpost for Iran. The Kharg Chemical Company's petrochemical plant is on stream processing natural gas into 605 T/D of LPG, and producing 585 T/D of sulfur. Chiyoda built this LPG/Sulfur Plant from the ground up, on a turn-key basis under a single responsibility. Despite the island's isolated location and torrid climate, Chiyoda commissioned the plant on schedule in just 25 months.



Key Technologies

Chiyoda's Technological Solutions in Overall Gas Value Chain

Chiyoda's engineering expertise in natural-gas-related facilities, such as pipelines, liquefaction, conversion to synthesis gas for chemicals production, etc, is second to none, due to our unsurpassed experience in EPC works for plants in the natural gas value chain. However Chiyoda does not reflect only on its past experience. Our research into and development of highly energy efficient technologies for synthesis gas production and its utilization will, in due course, lead to a greater reduction in the use of fossil fuel energy and help preserve the environment.

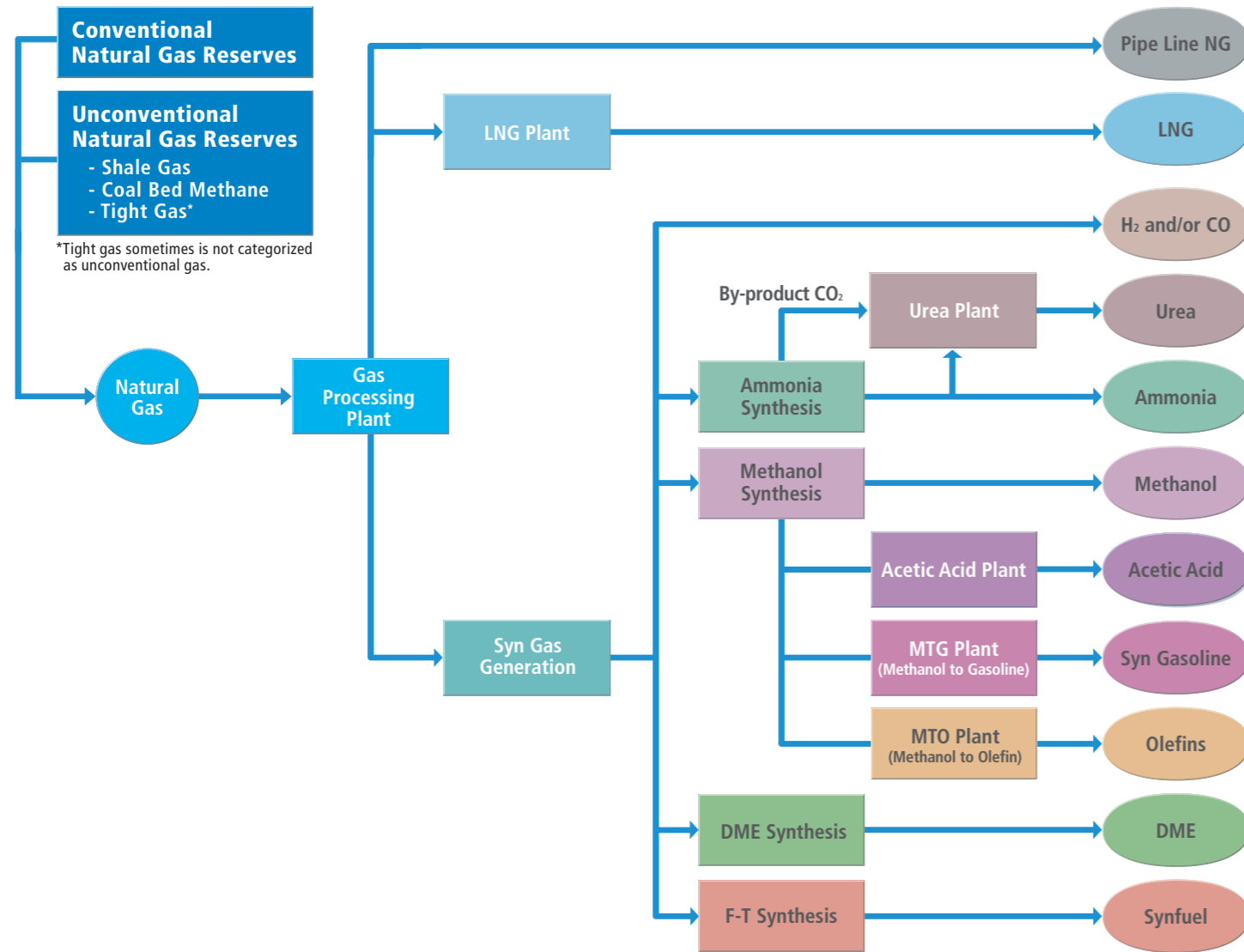

Courtesy of RasGas



4.7 MTPA LNG Plant



68,750 Nm³/Hr H₂ Plant



Fertilizer Complex (1,500 T/D Ammonia & 1,725 T/D Urea)



2,500 T/D Methanol Plant

Chiyoda's Advanced Technologies for Synthesis Gas and Chemical Production

A typical application of our advanced technologies in LNG plants is shown in the figure below. The CO₂ removed from the acid removal unit is used effectively by being converted, with high energy efficiency, into synthesis gas in a HiCOT reformer furnace. Synthesis gas is directly produced in CO₂ reforming process with an H₂ to CO molar ratio of 2.0 for the synfuel and methanol production. A part of methanol is converted to acetic acid in the ACETICA® process by using CO generated from the CO₂ reforming process.

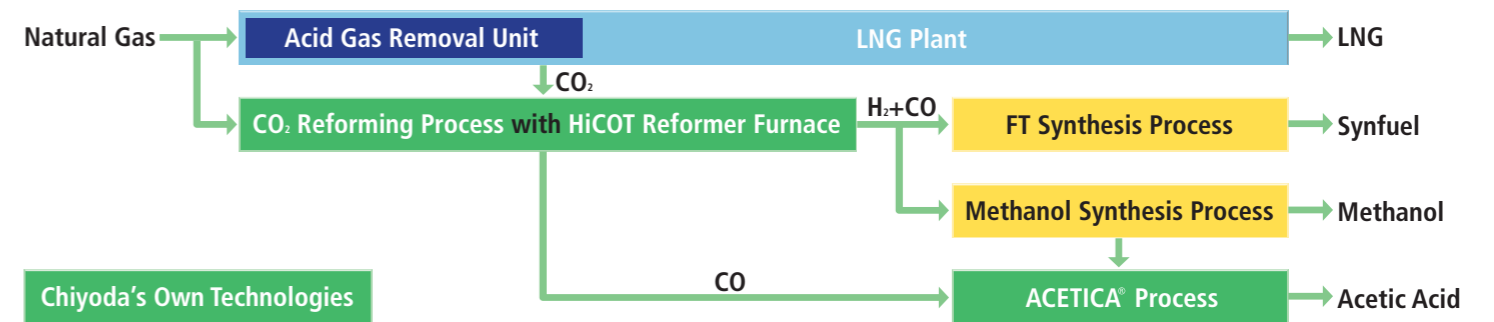

CO₂ Reforming Process

CT-CO₂AR™ is a unique and advanced technology utilizing CO₂ as a reforming agent to efficiently produce synthetic gases of varying H₂/CO ratios, and commercially proven technology as already more than 5 years operation at Japanese Chemical plant. This process is more effectively applied to production of carbon monoxide (CO) and low hydrogen to CO molar ratio of synthesis gas. By using this process 10 – 50 % of natural gas can be saved to produce CO in comparison with conventional catalysts. (https://www.youtube.com/watch?v=f6TtF_vm-E)

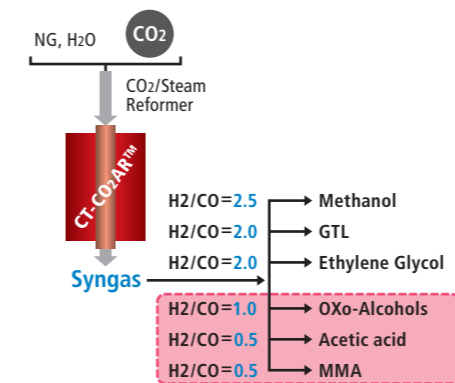

HiCOT Reformer Furnace

HiCOT reformer furnace makes use of high temperature air combustion technology with an invisible flame. This is a compact furnace which will reduce fuel consumption by around 40% and NOx emissions by around 70%.

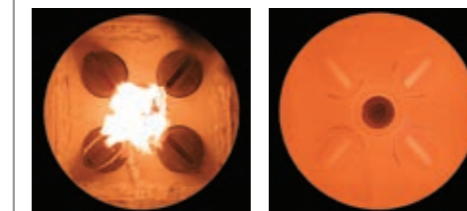

Ordinary Flame Region (Air ratio 3.0) HiCOT Region (Air ratio 1.3)



HiCOT Demonstration Plant (H₂:1,200 Nm³/Hr)

ACETICA® Process

ACETICA® process is a new acetic acid production process by the carbonylation of methanol in a heterogeneous catalyst system. Chiyoda has developed a bubble column reactor to remove the reaction heat efficiently, and a resin catalyst that has high activity, selectivity and stability.

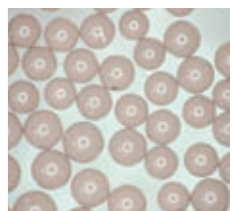

ACETICA® Resin Catalyst



ACETICA® Demonstration Plant (36,000 T/Y)



Minato Mirai Grand Central Tower
 4-6-2, Minatomirai, Nishi-ku,
 Yokohama 220-8765, Japan
www.chiyodacorp.com